

MB8450, MB8460 & MB8480 CarSonar-WR ²

Ultrasonic Proximity Sensor

The MB8450, MB8460 and MB8480 CarSonar-WR are high performance, low-cost ultrasonic proximity sensors designed to detect the side of a vehicle in a drive thru. The MB8450, MB8460 and MB8480 CarSonar-WR feature a simultaneous multi-sensor design which allows the sensor to operate even in the presence of other ultrasonic sensors. The MB8450 sensor utilizes a USB Micro-B connector for simple interfacing. The MB8460 and MB8480 use a simple pinout connection. Users can integrate many sensors into one system with little to no effect from the sensor-to-sensor interference which can occur with other ultrasonic sensor solutions. The CarSonar-WR features a True/False output and an optional range output. Deploying a network of ultrasonic sensors is simple and easy with the MB8450 interface. USB Factory calibration and testing is standard.



Features

- MB8450 has a USB interface for simple computer connection and installation.
- MB8460/MB8480 has a simple pinout connection
- CarSonar-WR has a simple True/False output and optional range output
- ~4.0 second object acquire time¹
- ~5.0 second object release time¹
- Filtered proximity output allows for multi-sensor operation
- IP67 Rated transducer
- Continually checks and outputs proximity information
- Learns nearby environment
- Sensor operates at 42KHz
- Range data from 50-cm to 500-cm

Benefits

- MB8450 has a USB interface for easy integration
- MB8450 USB Micro-B connector matches most smartphones
- Easily deploy network-based IT solutions with integrated ultrasonic sensors
- Reliable proximity information
- Sensor is a rangefinder/proximity sensor with a detection zone to the preset range to 150-cm
- Mounting holes provided
- Excellent for multiple sensor systems

Applications & Uses

- Drive thru ATMs
- Drive thru's
- Automated displays and advertising
- Proximity zone detection
- Kiosks and booths
- Multi-sensor arrays
- Car park signs
- Smart parking meters
- Parked car detection

Notes:

¹ Custom acquire and release times

² Please reference page 11 for part number key.

About Ultrasonic Sensors

Our ultrasonic sensors are non-contact object detection and ranging sensors that detect objects in air, within an area. These sensors are not affected by color or other visual characteristics of the detected object. Ultrasonic sensors use high frequency sound to detect and localize objects in a variety of environments. Ultrasonic sensors measure the time of flight for sound that has been transmitted to and reflected back from nearby objects. Based upon the time of flight, the sensor then outputs a range reading.

Close Range Operation

Applications requiring 100% reading-to-reading reliability should not use MaxSonar sensors at a distance closer than 50-cm. Although most users find MaxSonar sensors to work reliably from 0 to 50-cm for detecting objects in many applications, MaxBotix Inc., does not guarantee operational reliability for objects closer than the minimum reported distance. Because of ultrasonic physics, these sensors are unable to achieve 100% reliability at close distances.

Warning: Personal Safety Applications

We do not recommend or endorse this product be used as a component in any personal safety applications. This product is not designed, intended or authorized for such use. These sensors and controls do not include the self-checking redundant circuitry needed for such use. Such unauthorized use may create a failure of the MaxBotix Inc., product which may result in personal injury or death. MaxBotix Inc., will not be held liable for unauthorized use of this component.

MB8460 and MB8480 Pin Out

Pin 1-BW- Unused, leave disconnected or connect to circuit common ground.

Pin 2-PW- Digital Proximity Logic, outputs a High/Low logic voltage level depending on proximity detection. High means an object has been detected in the detection zone. Low means no object is present. There is a ~5.0 second delay on acquiring targets and a ~4.0 second delay for releasing a target once detected. This hysteresis improves sensor reliability.

Pin 3-AN- Analog Voltage Output: This pin outputs a single ended analog voltage scaled representation of the distance. This output is referenced to the sensor ground and Vcc. The scale factor is $(V_{cc}/1024)$ per 1-cm.

Pin 4-RX- This pin is internally pulled high. The MB8460 and MB8480 will continually measure and output proximity and range data. Leave the pin disconnected or hold the pin high for proximity information. Hold low to stop all sensor activity and reset acquire timers.



Pin 5-TX- The TX output delivers asynchronous serial with an RS232 format on MB8460 and TTL format on MB8480, except voltages are 0-Vcc. If a target is detected at 50-cm the output appears as follows: "R050 P0". The output is an ASCII capital "R", followed by three ASCII character digits representing the range in cm up to a maximum of 500-cm, followed by an ASCII space and the ASCII character "P", followed by one ASCII digit "1 or 0" corresponding to the proximity information, followed by a carriage return. Range information is provided for reference and is not considered accurate when more than one sensor is running in the same environment. Although the voltage of 0-Vcc is outside the RS232 standard, most RS232 devices have sufficient margin to read 0-Vcc serial data. If standard voltage level RS232 is desired, invert, and connect an RS232 converter such as a MAX232.

Pin 6-Positive Power, Vcc: The sensor is designed to operate at 5V DC. For best operation, the sensor requires that the DC power be free from electrical noise. (For installations with known dirty electrical power, a 100uF capacitor placed at the sensor pins between V+ and GND will typically correct the electrical noise.)

Pin 7-GND- Return for the DC power supply. GND (& Vcc) must be ripple and noise free for best operation.

General Description of Operation of the CarSonar-WR

The MB8450 sensor utilizes a USB Micro-B connector for interfacing. The MB8460 and MB8480 sensors utilize pinout connections as shown above. Each sensor is small in size with holes on the PCB for easy mounting. Each MB8450 sends serial data to the user's operating system (OS) which can then be read from the registered COM port (or equivalent) using a terminal program or read directly from the OS by using the appropriate software functions.

Each MB8450 is powered by the USB connection and begins operating after the USB handshaking has occurred. Range data and proximity information is sent continuously to the user's OS and is available to be read at any time.

Connection is handled automatically by device drivers that are available for most OSs (Windows XP and later, Linux Kernel 2.6 and later, Mac OS X and later.) The steps taken to perform the configuration vary slightly by the target OS, however, the general operation and the data sent by the sensor remains the same.

Serial Output Format

The sensor output is provided over the COM port (or equivalent) in an ASCII character format. If a target is detected at 30-cm the output appears as follows: "R050 P1<carriage return>". 50-cm is the minimum reported distance for the MB8450. The output is an ASCII capital "R", followed by three ASCII character digits representing the range in-cm up to a maximum of 500-cm. This is followed by an ASCII space and the ASCII character "P", followed by one ASCII digit "1 or 0" corresponding to the "True or False" proximity information, followed by a carriage return. A proximity value of "1" signifies that a target is present in the detection zone. A proximity value of "0" signifies that no target has been detected in the detection zone.

The MB8450, MB8460 and MB8480 CarSonar-WR has a set trigger distance of ~150-cm. Objects closer than this distance that fall within the sensor detection zone will charge the proximity timer. ~4.0 seconds later the sensor will begin sending the appropriate proximity information.

When the detected object then leaves the detection zone the sensor will "release" the target ~5.0 seconds later. Release time can be influenced by other nearby sensors and may appear to be longer in applications with many nearby sensors. The MB8450, MB8460 and MB8480 CarSonar-WR also doubles as an ultrasonic range finder. Range information is provided for reference and may experience noise when a large number of sensors (5+ depending on sensor mounting) are running in the same environment. The range reading will report the range to an object to the maximum range of the sensor of 500-cm. When no object is detected by the sensor, the sensor will report R500.

Using Multiple Sensors in a Single System

The CarSonar-WR is designed to function with other ultrasonic sensors operating in the same space at the same time on the same frequency. Our industry leading firmware allows users to connect multiple sensors across a single space without worrying about sensor interference (cross-talk). Each sensor is rated to work with a limited number of sensors within a space. For users working with large open environments or environments where sensors point in different directions, it is likely that the recommended number of sensors can be exceeded with little or no effect on user performance.

Sensor Calibration & Pairing

Each CarSonar-WR is shipped as a PCB and transducer pair. Each CarSonar-WR-PCB and CarSonar-WR-Transducer has received a custom calibration that matches and pairs the PCB and transducer performance. Installing a new or different transducer into a CarSonar-WR-PCB may result in unreliable performance.

WARNING - While it is understood that the transducer must be unplugged from the PCB to allow for installation, it is important for installation that the transducer and PCB remain as a pair for functional calibration.

Note: The transducer itself has an arrow with "up" located on it. Make sure when placing into housing applications the arrow with "up" is mounted in the forward position.

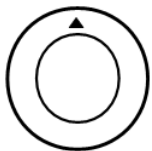

Front view of transducer with arrow, Make sure arrow is pointed up when looking at transducer.

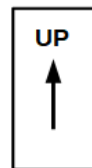

Top view of transducer with arrow, Make sure arrow is pointed out and forward.

The matching components of the MB8450, MB8460 and MB8480 CarSonar-WR are shipped together and are designed to be mounted in the final location as a PCB and transducer pair.

Terminal Configuration

Windows OS Configuration

The MB8450 CarSonar-WR inside Windows OS is a plug and play device. When the MB8450 ultrasonic proximity sensor is connected to a computer running Windows XP or newer, Windows will typically install and configure the device drivers automatically. This configuration may take several minutes, but the device configuration will only occur once.

Computers running Windows XP and older have HyperTerminal included in the OS. Computers running Windows Vista and newer require the installation of software that is able to communicate with a communication port.

To configure the MB8450 CarSonar-WR on computer systems running Windows, use the following directions:

1. Download a terminal program. A simple terminal program is available for download at www.maxbotix.com/terminal.htm
2. Unzip the terminal program to a folder of your choice, if using the provided program.
3. Connect the MB8450 ultrasonic proximity sensor to a computer with a Micro-B USB cable.
4. Allow Windows time to automatically configure MB8450 drivers.
5. Run the terminal program of preference. If using the provided program, run the .exe file. The program provided should look for the first available proximity sensor.
6. For users who operate with a different terminal program, set the configuration to the settings provided.

Warning:
 Removing the sensor before Windows has configured drivers may result in drivers being corrupted. Please allow time for Windows to fully install and configure drivers for the MB8450 CarSonar-WR.

If the provided software does not automatically find the first available MB8450 ultrasonic proximity sensor, use the following directions:

1. Click the “Settings” option.
2. In the “Serial port settings” window, change the “Port” option to the COM port number assigned to the MB8450 ultrasonic proximity sensor.

For multiple sensor operation, use the following instruction set:

1. Open a terminal window.
2. Click settings, if using the software provided for the MB8450 ultrasonic proximity sensor.
3. Change the “Port” menu to match the newest “COM#”
4. Click “ok”.

	MB8450	MB8460 & MB8480
	Value	Value
Baud	57600	9600
Data bits	8	8
Parity	0 / none	0 / none
Stop Bit	1	1
Flow Control	0 / none	0 / none

Other Operating Systems

For users that need drivers, they may be available for your system at <http://www.ftdichip.com/FTDrivers.htm>

Linux OS Configuration

(NOTE: Written with Ubuntu 12.10 & MoSerial Terminal Software)

1. Download and install a terminal program. A recommended program is available at http://www.maxbotix.com/terminal.htm
2. Configure the MB8450 CarSonar-WR.
3. Click "Port Setup".
4. Configure the following port settings: A. "Device" menu as "dev/ttyUSB0". B. Set Baud, Data Bits, Parity, and Stop Bits to match provided settings for the Windows configuration. C. Turn off all "Handshake" options. D. Click "OK".
5. Click "Connect".
6. Click the tab that says "Received ASCII".

	MB8450	MB8460 & MB8480
	Value	Value
Baud	57600	9600
Data bits	8	8
Parity	0 / none	0 / none
Stop Bit	1	1
Flow Control	0 / none	0 / none

Apple OS Configuration

To configure the MB8450 CarSonar-WR in Mac OS X operating systems use the following instruction set:

1. Download and install a terminal program. A recommended program is available at http://www.maxbotix.com/terminal.htm
2. Open settings.
3. Click "Modem Preferences".
4. Select "USBserial0" for the MB8450 sensor.
5. Set Baud, Data Bits, Parity, and Stop Bits to match the provided settings to the right.
6. Remove check boxes from "Flow Control" options.
7. Set "Service Name" to a name of preference .
8. "Phone Number", "Pre-dial init", and "Password" options can be left blank.

	MB8450	MB8460 & MB8480
	Value	Value
Baud	57600	9600
Data bits	8	8
Parity	0 / none	0 / none
Stop Bit	1	1
Flow Control	0 / none	0 / none

USB Latency

Computer USB ports have latency and buffer sizes which can change the time between the range readings reported by the MB8450 CarSonar-WR ultrasonic proximity sensors. This time delay can be caused by the USB hardware on the computer's system board, the chipset managing USB communication ports, the age of the computer hardware, the number of devices using USB communication and by the computer's OS.

When multiple USB connections are working in parallel, such as a mouse, keyboard and flash-drive, the bandwidth is shared among the devices. When bandwidth is shared between devices, the buffer and latency is increased due to the extra demand of resources from the computer chipset.

Low Latency Configuration

Windows Users (Advanced Low Latency Configuration)

For advanced Windows users, this instruction set will allow the use of a low-latency mode of operation for the MB8450 CarSonar-WR.

1. Open Windows' "Device Manager". This can often be accessed from the Windows' Control Panel.
2. Expand the "Ports (COM & LPT)" menu.
3. Select the COM port that is assigned to the MB8450 CarSonar-WR.
4. Right click on the COM port and go down to "Properties" on the new menu.
5. On the Communications Port Properties window select the "Port Settings" Tab.
6. Click on the option that says "Advanced".
7. Set the "Receive (Bytes)" option to 512.
8. Set the "Transmit (Bytes)" option to 512.
9. Set the "Latency Timer (msec)" option to 2.
10. The "Serial Enumerator" option should be checked. This setting makes Windows remember the COM port assigned to the device. When this is unchecked, Windows will assign it the first available Com Port.

Linux Users (Advanced Low Latency Configuration)

For advanced Linux users who want to operate in low-latency with the MB8450 CarSonar-WR, please use the following directions. While operating in low-latency mode, the USB buffer delay will be reduced to 128mS at most.

1. Open xTerm window.
2. Type the following command: <code>\$ dmesg grep FTDI</code> . a line that looks like <code>"/dev/ttyUSB#" </code> will be output.
3. Enter the following command: <code>\$ setserial /dev/ttyUSB# -g</code> . The # sign will be the USB port assigned to the MB8450. Information will be output that looks like <code>"/dev/ttyUSB#, UART: unk, PORT:0X0000, IRQ:0"</code> .
4. Enter the low latency command: <code>\$ setserial /dev/ttyUSB# low_latency</code> . This command will set the MB8450 into low-latency mode.
5. It is recommended to test that the configuration has been confirmed. To do this enter the command: <code>\$ setserial /dev/ttyUSB# -g</code> . The low-latency flag should be appended as follows: <code>"/dev/ttyUSB#, UART: unk, PORT: 0X0000, IRQ: 0, Flags: low_latency"</code> .

Mechanical Dimensions

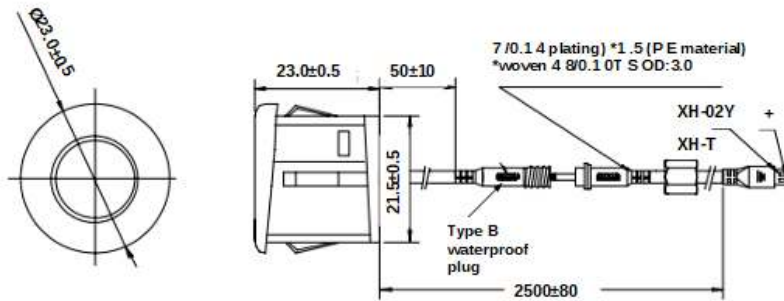
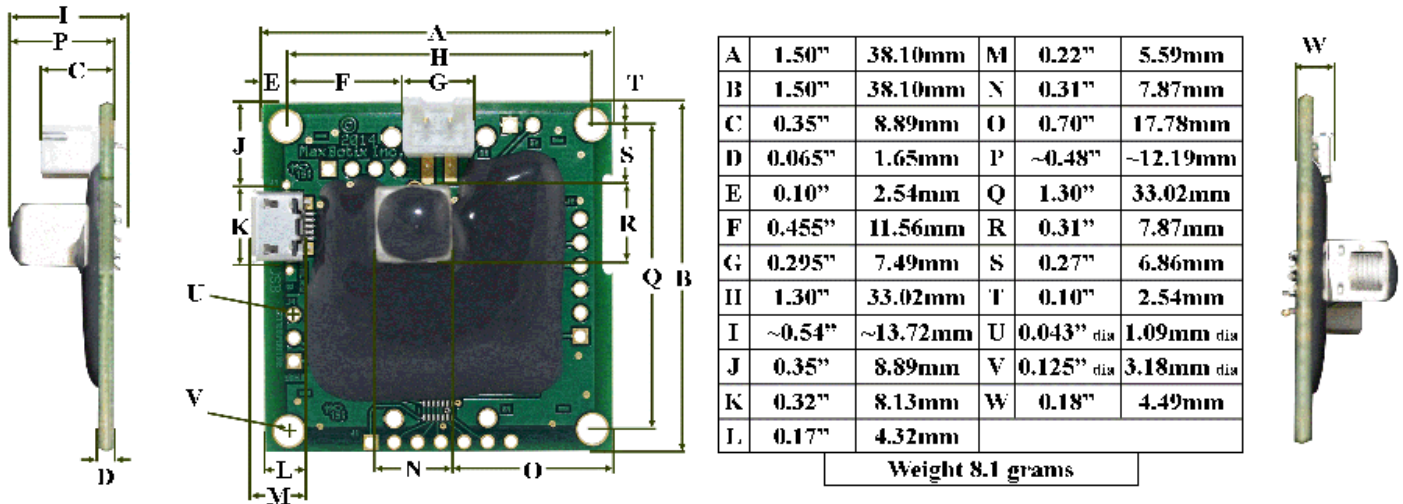

Note: Dimension for “K ” and “W” are not applicable on MB8460/MB8480 CarSonar-WR sensors.
The recommended operating and storage temperature of the CarSonar-WR is $-40C$ to $+75C$.

Mounting Height

When mounting the CarSonar-WR, the recommended placement height of the transducer is between 50-cm and 70.5-cm above the ground. This range in mounting height helps to ensure that the sensor will be pointed at the side panel of most vehicle makes and models for more accurate detection information. Mountings lower than 50-cm may cause the sensor to fail to detect vehicles with high ground clearance such as trucks, and mountings that place the transducer higher than 71-cm may cause the sensor to fail to detect lower profile vehicles such as sports cars.

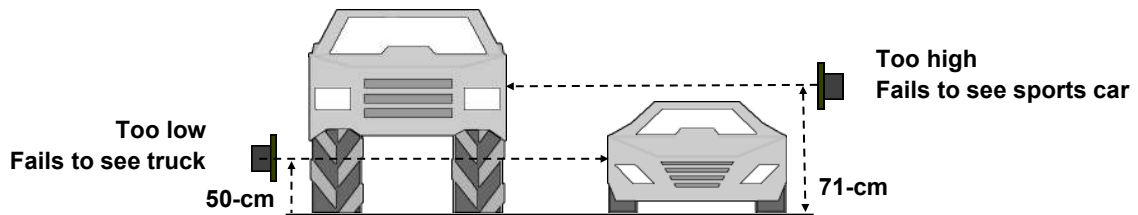

Transducer Mounting Hole

For proper performance the transducer must be mounted into a flat plate within a 21.5 mm + 0.2 mm hole. To fully stake the transducer also apply a small amount of electronic grade RTV (Loctite 5145 or comparable).

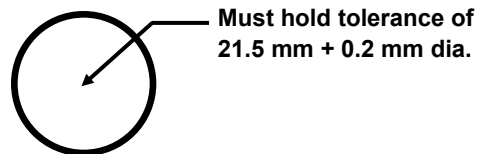

Angle of Incidence

The functional angle of incidence for the CarSonar-WR is $\pm 21^\circ$ at one meter to a work target. The angle of incidence will decrease as the range to the target increases or as the target size decreases.

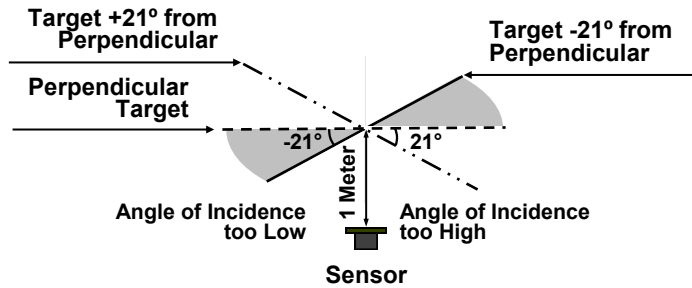

The CarSonar-WR Detection Zone

Different applications require different sensors. Each sensor is matched to provide the approximate detection zone shown in this datasheet. This allows end users to select the part number that matches their given sensing application. Each part number has a consistent field of detection so additional units of the same part number will have similar detection zones. The beam patterns are provided to help identify an estimated detection zone for an application based on the acoustic properties of a target versus the plotted beam patterns.

Each detection zone is a 2D representation of the detection area of the sensor. The detection zone is actually shaped like a 3D cone (having the same detection pattern both vertically and horizontally). Detection patterns for dowels are used to show the detection zone of each sensor. Dowels are long cylindrical targets of a given diameter. The dowels provide consistent target detection characteristics for a given size target which allows for easy comparison of one CarSonar-WR and another CarSonar-WR.

For each part number, the four patterns (A, B, C and D) represent the detection zone for a given target size. Each beam pattern shown is determined by the sensor's part number and target size.

The actual beam angle changes over the full range. Use the detection zone for a specific target at any given distance to calculate the beam angle for that target at the specific distance. Generally, smaller targets are detected over a narrower beam angle and a shorter distance. Larger targets are detected over a wider beam angle and a longer range.

MB8450, MB8460 & MB8480 CarSonar-WR

The MB8450, MB8460 & MB8480 CarSonar-WR has a proximity detection zone of 150-cm.

MB8450-000 MB8460-000 MB8480-000

CarSonar®-WR™ Detection Zone

Sample results for measured beam pattern are shown on a 30-cm grid. The detection pattern is shown for dowels of varying diameters that are placed in front of the sensor.

A 6.1-mm (0.25-inch) diameter dowel

B 2.54-cm (1-inch) diameter dowel

C 8.89-cm (3.5-inch) diameter dowel

..... Partial Detection

— 5.0V

D 11-inch wide board moved left to right with the board parallel to the front sensor face.

This shows the sensor's range capability.

Note: For people detection the pattern typically falls between charts A and B.

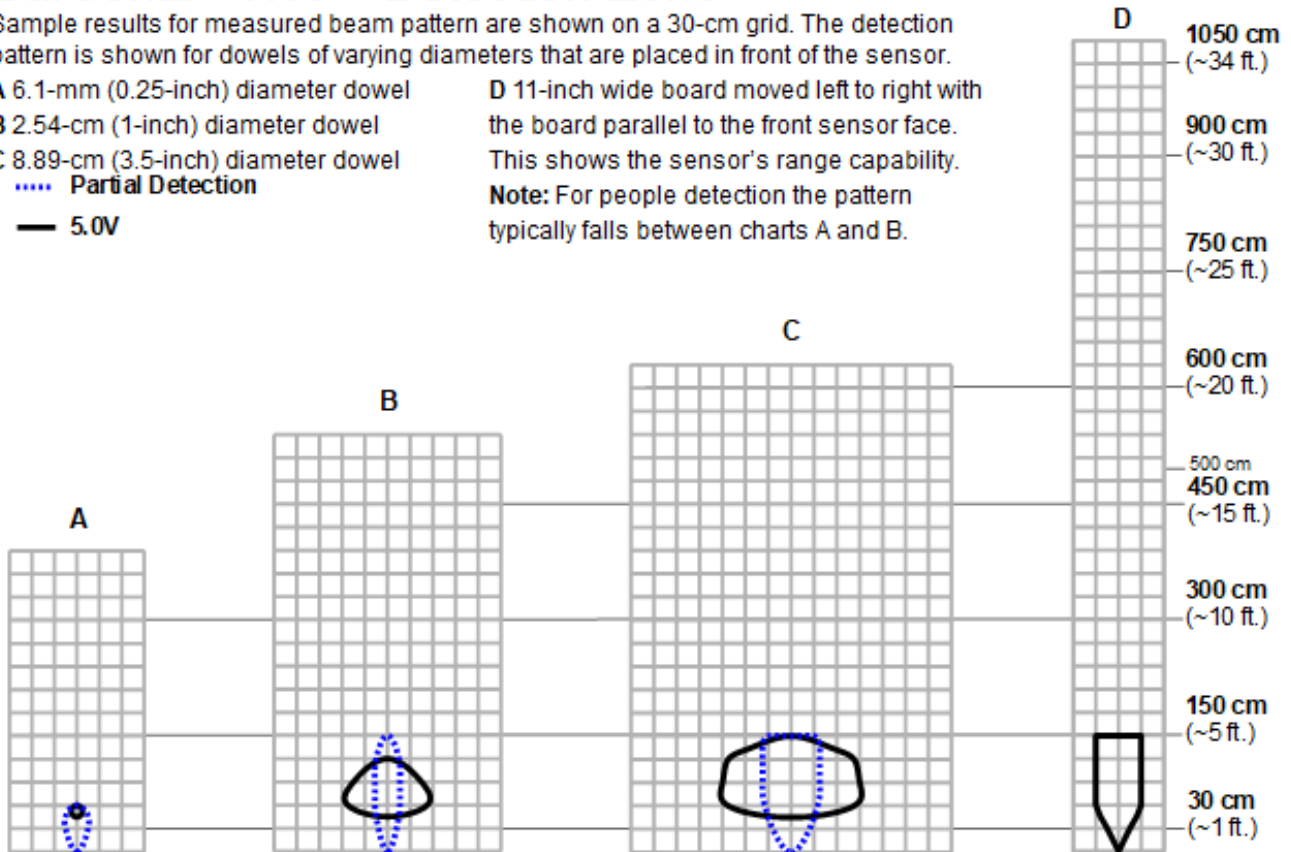

Beam Characteristics are Approximate

Beam Pattern drawn to a 1:95 scale for easy comparison to our other products.

MaxBotix® Inc.

For more information or latest product datasheets visit: www.maxbotix.com

The names MaxBotix, MaxSonar, EZ0, EZ1, EZ2, EZ3, EZ4, AE0, AE1, AE2, AE3, AE4, and WR1 are trademarks of MaxBotix Inc.

MB8450 CarSonar-WR

The MB8450, MB8460 & MB8480 CarSonar-WR outputs range information to a maximum range of 5 meters. The beam pattern below shows the beam pattern for the range information that is output by the sensor in the serial data string.

MB8450-000 MB8460-000 MB8480-000

CarSonar®-WR™ Beam Pattern

Sample results for measured beam pattern are shown on a 30-cm grid. The detection pattern is shown for dowels of varying diameters that are placed in front of the sensor.

- A 6.1-mm (0.25-inch) diameter dowel
- B 2.54-cm (1-inch) diameter dowel
- C 8.89-cm (3.5-inch) diameter dowel
- Partial Detection
- 5.0V

D 11-inch wide board moved left to right with the board parallel to the front sensor face. This shows the sensor's range capability.
Note: For people detection the pattern typically falls between charts A and B.

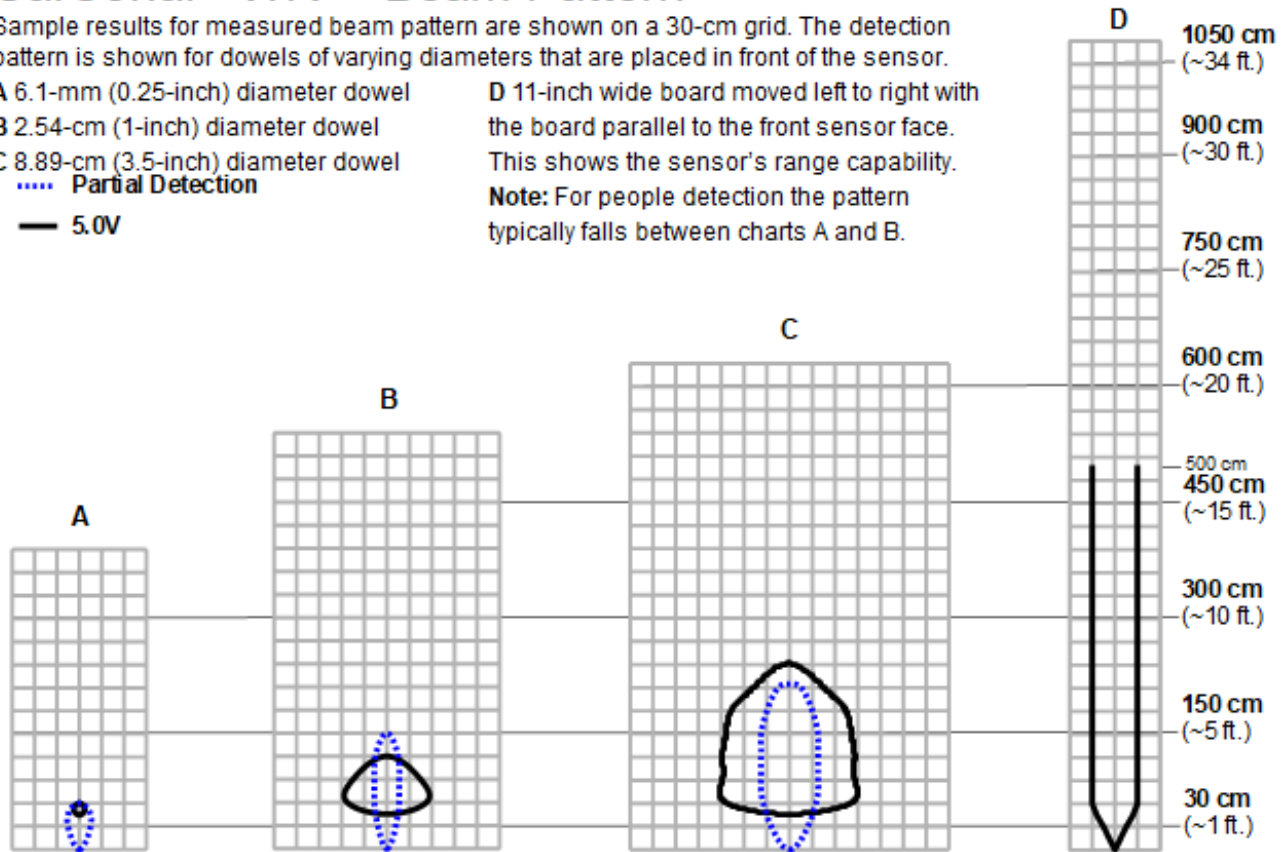

Beam Characteristics are Approximate

Beam Pattern drawn to a 1:95 scale for easy comparison to our other products.

MaxBotix® Inc. For more information or latest product datasheets visit: www.maxbotix.com
The names MaxBotix, MaxSonar, EZ0, EZ1, EZ2, EZ3, EZ4, AE0, AE1, AE2, AE3, AE4, and WR1 are trademarks of MaxBotix Inc.

Part Numbers

All part numbers are a combination of a six-character base followed by a dash and a three-digit product code. Please review the following table for more information on the three-digit product code.

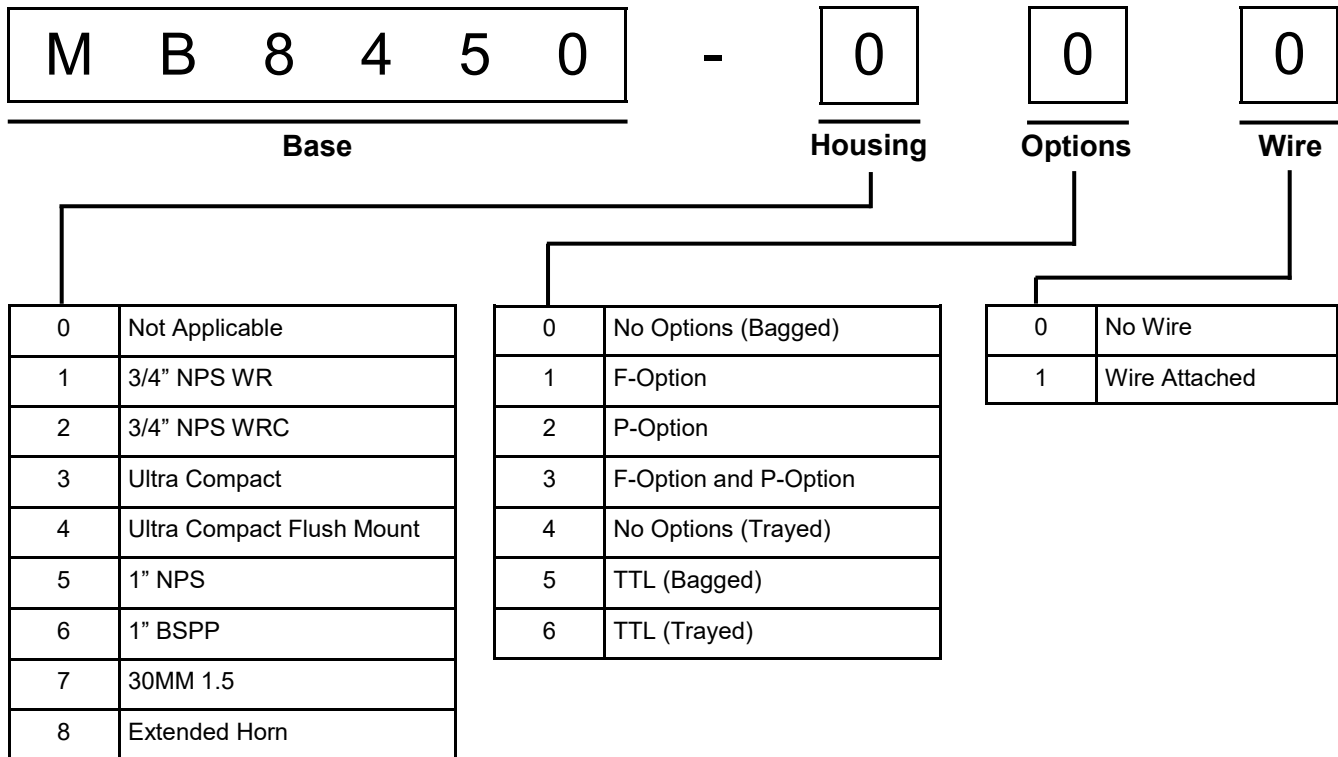

The following table displays all of the active and valid part numbers for this product.

Active Part Numbers		
MB8450-000	MB8460-000	MB8480-000
	MB8460-001	MB8480-001

After reviewing this datasheet, do you have any more questions?

We offer Technical Support on all of our products even if you purchased them through one of our many vendors worldwide.

You can **fill out a Technical Support form** for assistance on a sensor here --> [Technical Support](#)

Not sure which sensor you need for your application?

We offer Sensor Selection Assistance, click the link here to fill out a form for support --> [Sensor Selection Help](#)

Looking for tutorials to help you get started?

[Frequently Asked Questions about Our Sensors](#)

We receive many questions about our products and services. This resource offers answers to common inquiries we receive about our product lines and their application.

[Fully Calibrated Beam Patterns](#)

All of our sensors are factory calibrated to provide consistent beam patterns, detection zones, to fit into a wide variety of applications. In our product lines, each model number comes with a different beam pattern that reflects the sensitivity and the detection zone of how it sees a target. Additionally, we strive to maintain consistency between our finished products, and you will see little to no deviation between sensors of the same model. This allows you to have confidence in your final application when using multiple sensors.

[Understanding Range Readings](#)

The success of an application may hinge upon knowing the exact location of a target. However, a sensor may report one meter even if the target is not exactly one meter away from the sensor. Sensor specifications, such as resolution, precision, and accuracy, help you to understand sensor performance.

[How to Use Multiple Ultrasonic Sensors](#)

This guide covers three ways to run your sensors in a Multiple Sensor environment and issues you may face.

Contact us now with any questions at sales@maxbotix.com or call +1-218-454-0766.

Please call during our preferred business hours of 8:00 am – 4:30 pm EST on Monday through Thursday and 8:00 am – 2:00 pm EST on Friday, or you may leave us a voicemail anytime.